

Kit de refacciones para mantenimiento preventivo. / Kit of parts for preventive maintenance.

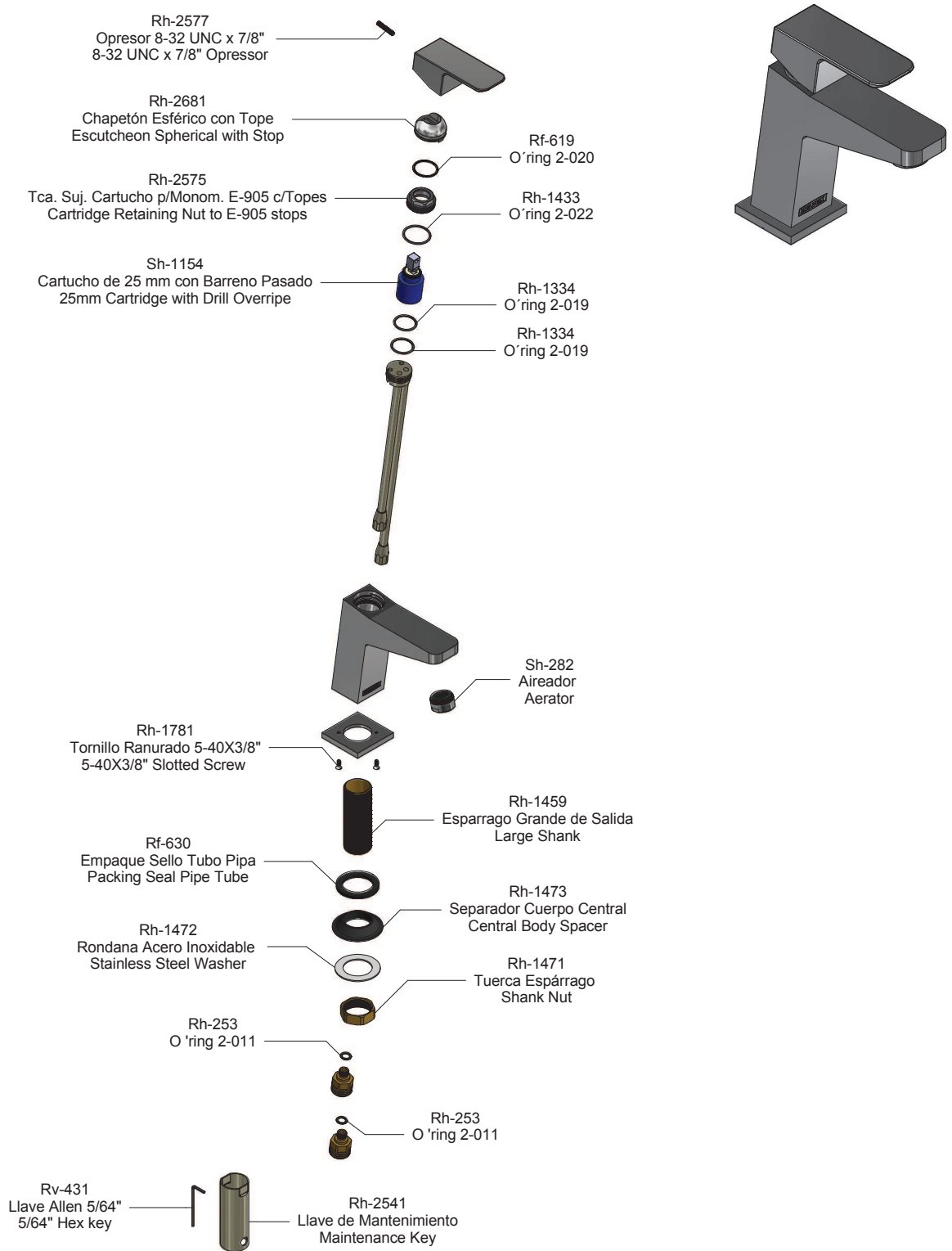

Sub-ensambles / Sub-assemblies



Sh-1404
Inserto Soldado p/ Monomando
Solder Insert for Mixer



Sh-282
Aireador
Aerator

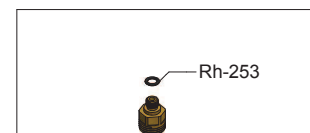

Sh-1367
Tuerca Conector c/ Oring
Nut Connector with O'ring

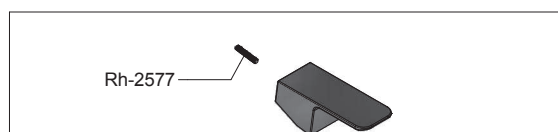

Sh-1436
Maneral p/ Monomando
Handle to Mixer

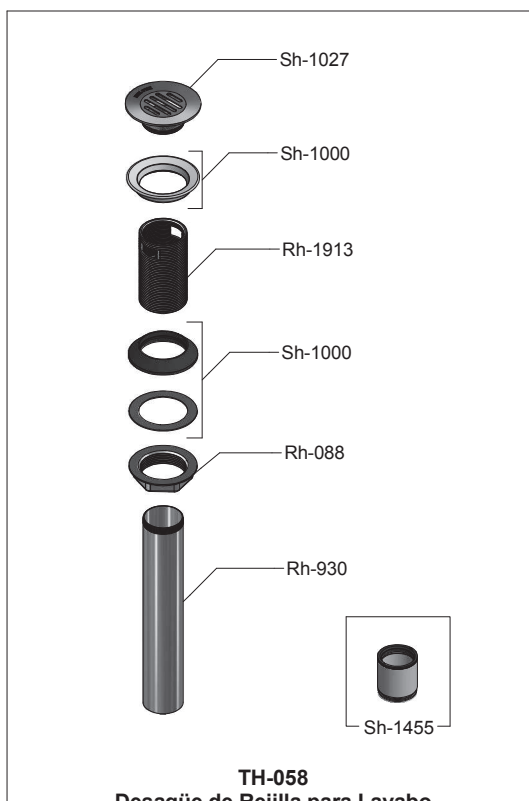

TH-058
Desagüe de Rejilla para Lavabo
Lavatory Grid Drain

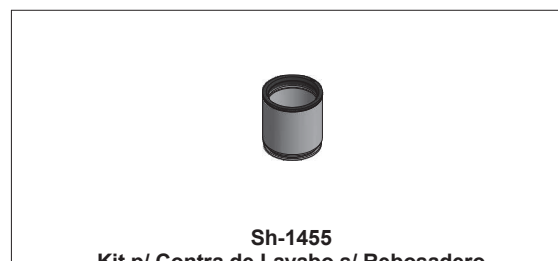

Sh-1455
Kit p/ Contra de Lavabo s/ Reboadero
Grid Drain or Fungus Type Kit

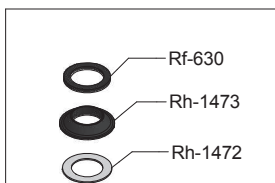

Sh-1408
Kit Empaques
Gaskets Kit

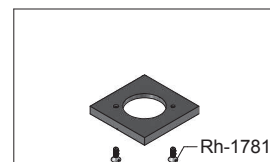

Sh-1506
Chapetón con Tornillos
Screws with Escutcheon

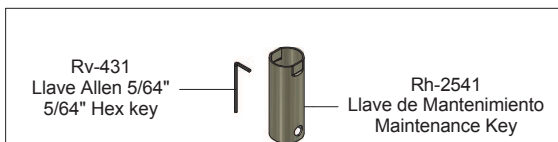

Sh-1477
Kit de Llaves de Mantenimiento
Maintenance Key Kit

