

Kit de refacciones para mantenimiento preventivo. / Kit of parts for preventive maintenance.

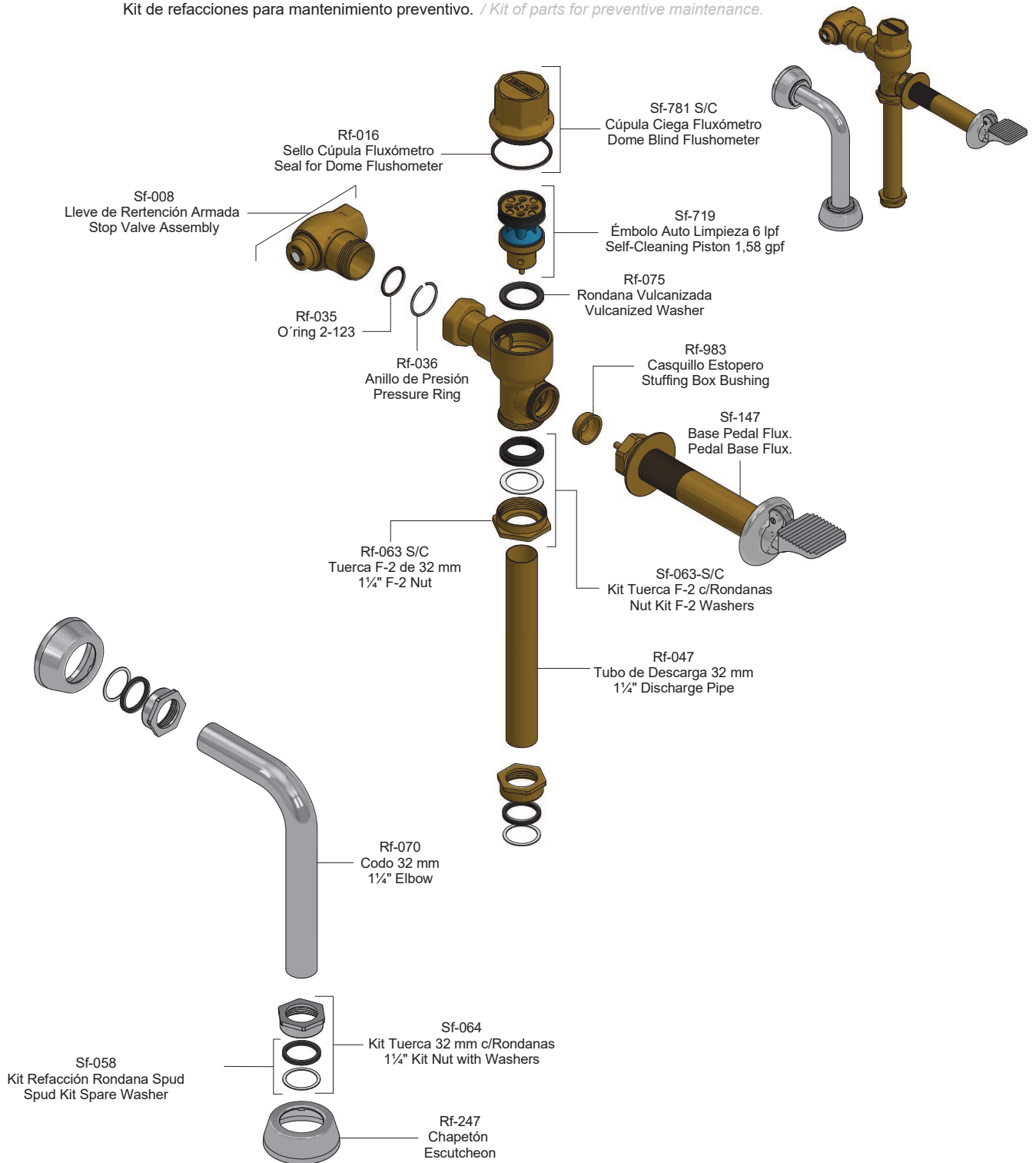

Kit de Refacciones para Mantenimiento Preventivo  
*/ Kit of Parts for Preventive Maintenance*

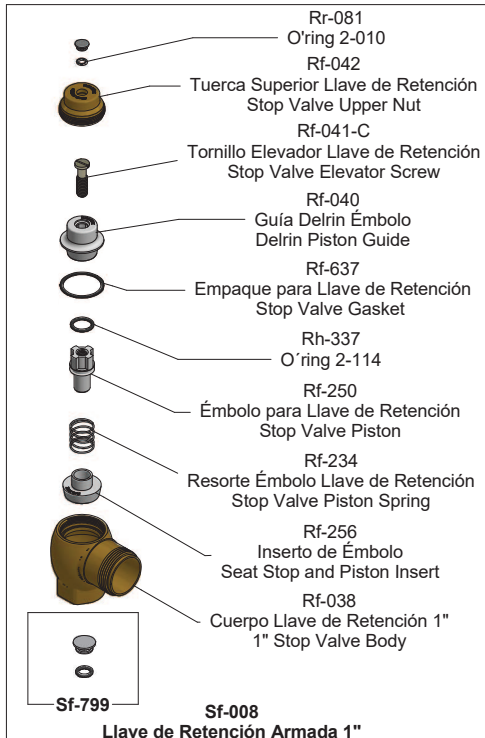

Rf-081 O'ring 2-010  
Rf-042 Tuerca Superior Llave de Retención Stop Valve Upper Nut  
Rf-041-C Tornillo Elevador Llave de Retención Stop Valve Elevator Screw  
Rf-040 Guía Delrin Émbolo Delrin Piston Guide  
Rf-637 Empaque para Llave de Retención Stop Valve Gasket  
Rh-337 O'ring 2-114  
Rf-250 Émbolo para Llave de Retención Stop Valve Piston  
Rf-234 Resorte Émbolo Llave de Retención Stop Valve Piston Spring  
Rf-256 Inserto de Émbolo Seat Stop and Piston Insert  
Rf-038 Cuerpo Llave de Retención 1" 1" Stop Valve Body  
Sf-799  
Sf-008  
**Llave de Retención Armada 1" 1" Assembled Stop Valve**

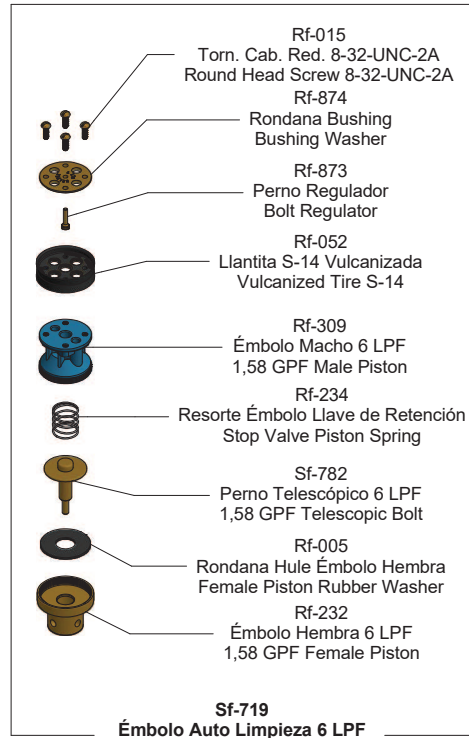

Rf-015 Torn. Cab. Red. 8-32-UNC-2A Round Head Screw 8-32-UNC-2A  
Rf-874 Rondana Bushing Bushing Washer  
Rf-873 Perno Regulador Bolt Regulator  
Rf-052 Llantita S-14 Vulcanizada Vulcanized Tire S-14  
Rf-309 Émbolo Macho 6 LPF 1,58 GPF Male Piston  
Rf-234 Resorte Émbolo Llave de Retención Stop Valve Piston Spring  
Sf-782 Perno Telescópico 6 LPF 1,58 GPF Telescopic Bolt  
Rf-005 Rondana Hule Émbolo Hembra Female Piston Rubber Washer  
Rf-232 Émbolo Hembra 6 LPF 1,58 GPF Female Piston  
Sf-719  
**Émbolo Auto Limpieza 6 LPF Self-Cleaning Piston 1,58 GPF**

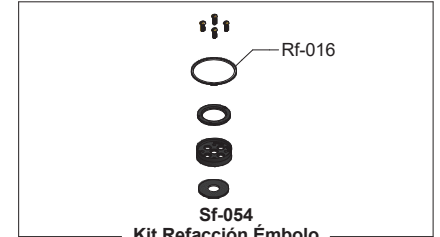

Rf-016  
Sf-054  
**Kit Refacción Émbolo Spare Piston Kit**

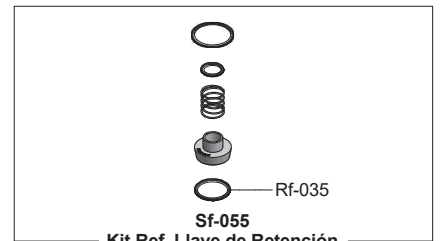

Rf-035  
Sf-055  
**Kit Ref. Llave de Retención Stop Valve Kit**



Sf-056  
**Kit Refacción Manija y Pedal Spare Handle and Pedal Kit**

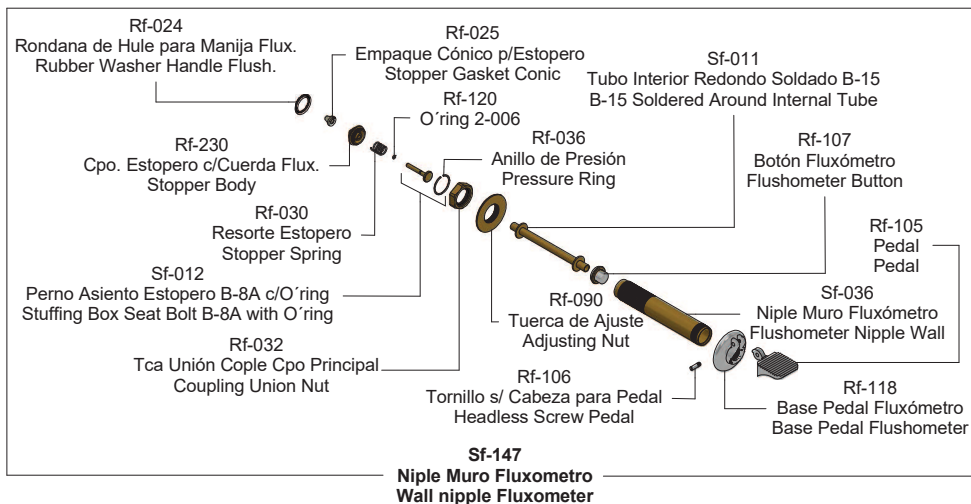

Rf-024 Rondana de Hule para Manija Flux. Rubber Washer Handle Flush.  
Rf-230 Cpo. Estopero c/Cuerda Flux. Stopper Body  
Rf-030 Resorte Estopero Stopper Spring  
Sf-012 Perno Asiento Estopero B-8A c/O'ring Stuffing Box Seat Bolt B-8A with O'ring  
Rf-032 Tca Unión Cople Cpo Principal Coupling Union Nut  
Rf-025 Empaque Cónico p/Estopero Stopper Gasket Conic  
Rf-120 O'ring 2-006  
Rf-036 Anillo de Presión Pressure Ring  
Rf-090 Tuerca de Ajuste Adjusting Nut  
Rf-106 Tornillo s/ Cabeza para Pedal Headless Screw Pedal  
Sf-011 Tubo Interior Redondo Soldado B-15 B-15 Soldered Around Internal Tube  
Rf-107 Botón Fluxómetro Flushometer Button  
Rf-105 Pedal Pedal  
Sf-036 Niple Muro Fluxómetro Flushometer Nipple Wall  
Rf-118 Base Pedal Fluxómetro Base Pedal Flushometer  
Sf-147  
**Niple Muro Fluxómetro Wall nipple Fluxometer**

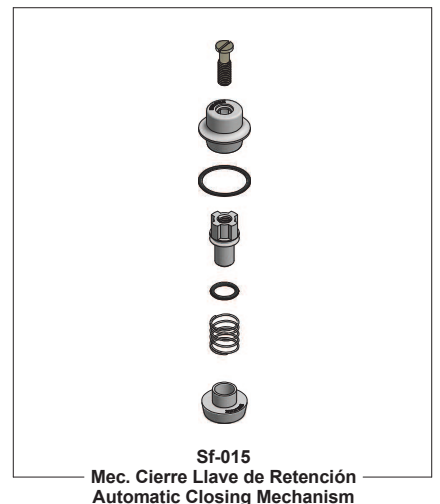

Sf-015  
**Mec. Cierre Llave de Retención Automatic Closing Mechanism**

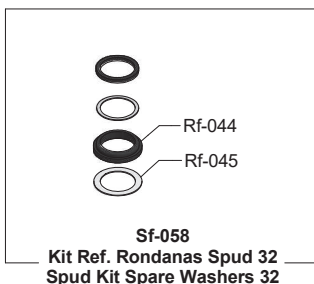

Rf-044  
Rf-045  
Sf-058  
**Kit Ref. Rondanas Spud 32 Spud Kit Spare Washers 32**

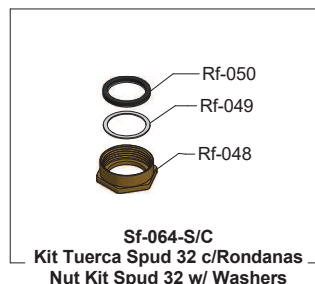

Rf-050  
Rf-049  
Rf-048  
Sf-064-S/C  
**Kit Tuerca Spud 32 c/Rondanas Nut Kit Spud 32 w/ Washers**

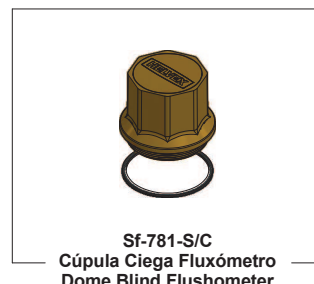

Sf-781-S/C  
**Cúpula Ciega Fluxómetro Dome Blind Flushometer**



Sf-110  
**Estopero Armado Flux. c/ Cuerda Armed Estopero Flux. w/ Rope**